



LITHIUM THIONYL CHLORIDE BATTERY

锂亚硫酰氯电池 | 型号: ER18505

Characteristics 性能数据

Nominal capacity(1mA-2.0v-25°C).....	4000mAh
标称容量	
Nominal voltage.....	3.6v
额定电压	
Max.constant current.....	130mA
最大连续工作电流	
Max.pulse current.....	200mA
最大脉冲电流	
Weight.....	32g
电池重量	
Volume.....	Φ 18.5X50.5mm
电池尺寸	
Workable temperature.....	-60°C ~ +85°C
工作温度	

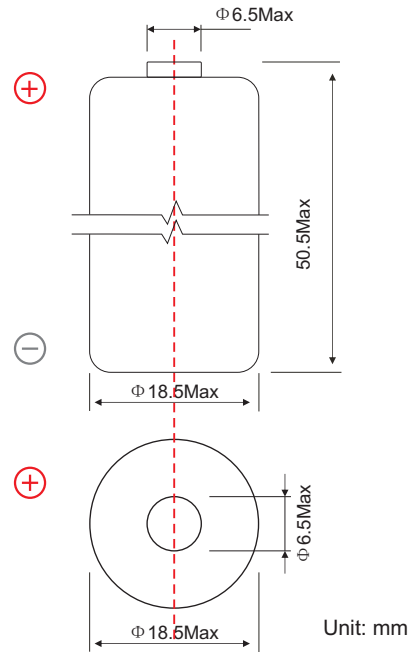

极端样式可按照客户要求定做

Discharge characteristic 放电特性 (25°C)

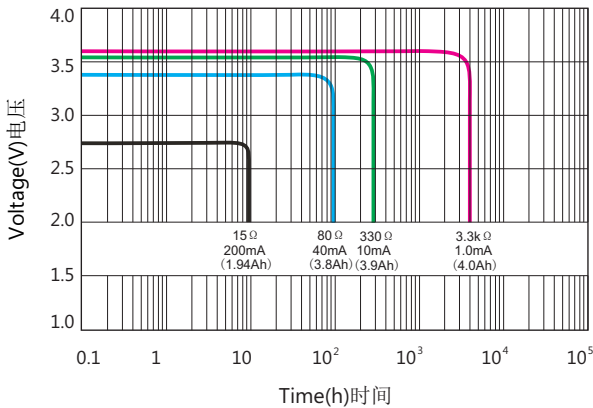

Voltage vs temperature 电压 vs 温度

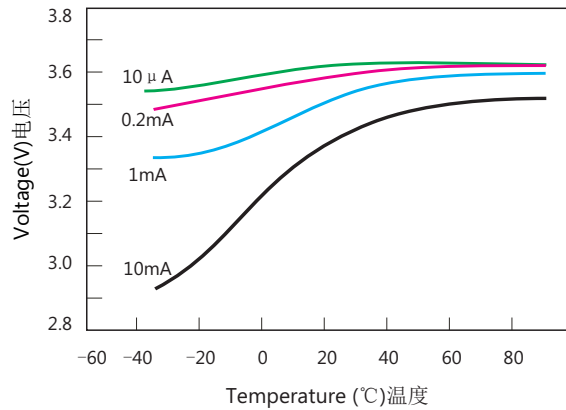

Capacity vs current 容量 vs 电流

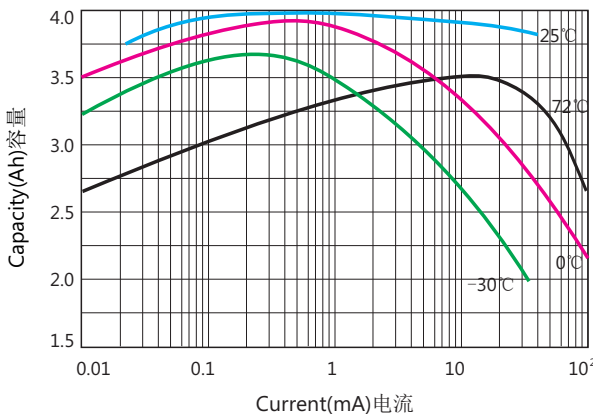

Storage characteristics 存储特性

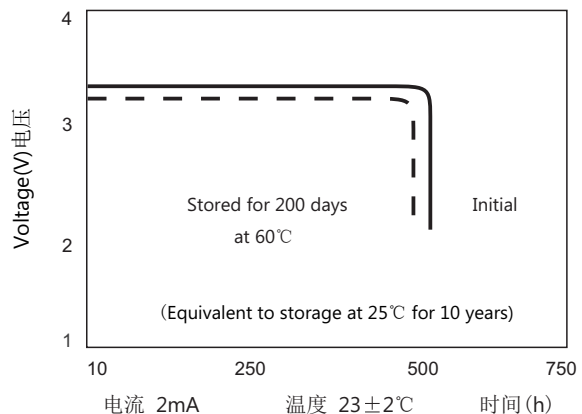

ZINCHU - литиевые элементы питания

Офис-склад: г. Красногорск, ш. Ильинское, д. 1А, оф. 30, этаж 2
Тел.: 8-499-350-32-34 Сайт: www.zinchu.ru E-mail: sales@zinchu.ru